



INSTRUCTION MANUAL

Models 1620A / 1621A / 1622A / 1623A / 1626A / 1627A

DC REGULATED POWER SUPPLIES

Limited One-Year Warranty

B&K Precision Corp. warrants to the original purchaser that its product and the component parts thereof, will be free from defects in workmanship and materials for a period of one year from the date of purchase.

B&K Precision Corp. will, without charge, repair or replace, at its' option, defective product or component parts. Returned product must be accompanied by proof of the purchase date in the form a sales receipt.

To obtain warranty coverage in the U.S.A., this product must be registered by completing and mailing the enclosed warranty card to B&K Precision Corp., 22820 Savi Ranch Pkwy, Yorba Linda, CA 92887 within fifteen (15) days from proof of purchase.

Exclusions: This warranty does not apply in the event of misuse or abuse of the product or as a result of unauthorized alternations or repairs. It is void if the serial number is alternated, defaced or removed.

B&K Precision Corp. shall not be liable for any consequential damages, including without limitation damages resulting from loss of use. Some states do not allow limitation of incidental or consequential damages, so the above limitation or exclusion may not apply to you.

This warranty gives you specific rights and you may have other rights, which vary from state-to-state.

Model Number: _____

Date Purchased: _____



INSTRUCTION MANUAL

for

1620A / 1621A / 1622A / 1623A / 1626A / 1627A
DC REGULATED POWER SUPPLIES

CONTENTS

| | |
|--|-----------|
| 1. INTRODUCTION | 4 |
| 2. FEATURES | 4 |
| 3. SPECIFICATIONS | 5 |
| 4. PRECAUTIONS FOR USE | 7 |
| 4.1 CONFIRMING THE SUPPLY RANGE | 7 |
| 4.2 PRECAUTIONS FOR CONNECTION OF OUTPUT TERMINALS | 7 |
| 4.3 OPERATING ENVIRONMENT | 7 |
| 5. EXPLANATION OF PANELS | 8 |
| 5.1 FRONT PANEL | 8 |
| 5.2 REAR PANEL | 10 |
| 6. OPERATION PROCEDURES | 11 |
| 6.1 STAND-ALONE OPERATION | 11 |
| 6.2 SERIAL CONNECTION | 11 |
| 6.3 PARALLEL OPERATION (MASTER/SLAVE CONTROL) | 12 |
| 7. MAINTENANCE | 14 |
| 7.1 MAIN FUSE REPLACEMENT | 14 |
| 7.2 CALIBRATIONS | 14 |
| 7.3 VOLTAGE CALIBRATION | 15 |
| 7.4 VOLTMETER ALIGNMENT | 15 |
| 7.5 CURRENT CALIBRATION | 15 |
| 7.6 AMMETER ALIGNMENT | 15 |

1. INTRODUCTION

The **BK Precision Analog and Digital** series are high quality serial control type DC regulated power supplies. These models can be operated at constant voltage or constant current mode whose output can be varied from 0 up to the rated values for respective model.

It is a compact unit which, provided with separate voltage and current meters (**Analog for 1620, 1622, 1626 and 3-digits LEDS for 1621, 1623, 1627**) for monitoring of the output voltage and current simultaneously. In terms of operability, the unit enable high precision, continuous variability via coarse and fine adjust knobs. The **BK Precision Analog and Digital** series also provide the possibility to connect multiple units of the same model in parallel to set up a "master/slave" configuration to increase the output current capability. On the other hand, serial connection of multiple units can be used to increase the output voltage level.

This family of power supplies provide clean and stable DC output which are most suitable for many areas including laboratory, industrial, field service, hobby and telecommunication applications.

2. FEATURES

- The **BK Precision Analog and Digital** are constant voltage/constant current power supplies which features excellent line and load regulations, low ripple and noise characteristics.
- The unit features separate voltage and current meters so that output voltage and current can be monitored simultaneously.
- Output voltage and current can be adjusted continuously in full range to any desired values. Adjustment can be done easily and precisely by using separate coarse and fine adjust knobs.
- The constant current circuit operates to protect against overload and output short circuit. The limiting current values can be preset in full range of the rated values for respective model.
- Multiple units of power supplies of the same family can be connected in series to provide higher output voltage.
- Multiple units of power supplies of SAME model can be connected in parallel (master/slave configuration) to achieve higher output current.

3. SPECIFICATIONS

| | 1620A | 1622A | 1626A | 1621A | 1623A | 1627A |
|---|---------------------------------|--------------|--------------|----------------|--------------|--------------|
| Output voltage | 0 - 18V | 0 - 60V | 0 - 30V | 0 - 18V | 0 - 60V | 0 - 30V |
| Output current | 5A | 1.5A | 3A | 5A | 1.5A | 3A |
| CONSTANT VOLTAGE CHARACTERISTICS | | | | | | |
| Load regulation (0-100%) | 0.02% + 3mV | | | | | |
| Line regulation (+/- 10%) | 0.02% + 3mV | | | | | |
| Ripple noise, rms | 1mV max. | | | | | |
| CONSTANT CURRENT CHARACTERISTICS | | | | | | |
| Load regulation (0-100%) | 0.02% + 3mV | | | | | |
| Line regulation (+/- 10%) | 0.02% + 3mV | | | | | |
| OUTPUT | | | | | | |
| Output terminal (color) | (+) Red, (-) Black, (GND) Green | | | | | |
| Ground proof voltage | +/- 180V | | | | | |
| INSTRUMENTATION | | | | | | |
| Voltmeter | Analog | | | LED | | |
| Ammeter | Analog | | | LED | | |
| Voltmeter accuracy | ± 7% fs | | | ± 1% + 1 digit | | |
| Ammeter accuracy | ± 7% fs | | | ± 1% + 1 digit | | |

| | 1620A | 1622A | 1626A | 1621A | 1623A | 1627A |
|---|---|-------|----------------|--------------------|-------|-------|
| FUNCTIONS | | | | | | |
| Serial connection (independent control mode) | Can be connected in series (within limits of ground proof voltage) | | | | | |
| Parallel operation (master - slave mode) | Can be operated in “ one - control “ parallel configuration (only same model) | | | | | |
| Cooling system | NATURAL CONVECTION | | | | | |
| POWER CONSUMPTION | | | | | | |
| VA/W (for rated load of AC 220V) | Approximate 210 | | | Approximate 220 | | |
| INPUT VOLTAGE | | | | | | |
| Voltage, frequency | 220V , 50Hz (or on request) | | | | | |
| Operating ambient temperature | 5 to 40°C | | 10 - 80 % R.H. | | | |
| DIMENSIONS AND WEIGHT | | | | | | |
| Dimensions (width x height x depth) | 205 x 115 x 270 mm | | | | | |
| Weight | Approximate 6Kgs | | | Approximate 7.4Kgs | | |
| FUSE RECOMMENDED | | | | | | |
| Input fuse F2 | | | | | | |
| AC 100V , 110V , 120V | 3AF | | | | | |
| AC 220V , 230V , 240V | 2AF | | | | | |
| Internal fuse F1 | 500mAF | | | | | |

■ Circuit and ratings subject to change without notice due to developments in technology.

4. PRECAUTIONS FOR USE

4.1 CONFIRMING THE SUPPLY RANGE

The units must be used within its specified range. The rated input voltage can be found on the rating label under the unit. Before plugging into the AC supply outlet, check whether the input rating conform with your local supply. For certain models, a voltage selector is available, please switch the voltage selector to the appropriate position before use.

4.2 PRECAUTIONS FOR CONNECTION OF OUTPUT TERMINALS

This unit is floating type power supply. For ordinary use, be sure that the MASTER/SLAVE switch on the real panel is set to MASTER position and either the (+) output terminal or the (-) terminal is connected to the GND terminal (chassis GND) via the shorting bar.

4.3 OPERATING ENVIRONMENT

- Be sure to use this unit within the specified ambient temperature range listed in the specification table.
- Because the unit is cooled by natural convection,

do not place objects on top to block the convection. Also, user must avoid to place the unit on or near any heat emitting devices or use multiple units in stacked configuration. For best result, use the unit in an environment that is as well cross-ventilated as possible.

5.EXPLANATION OF PANELS

5-1. FRONT PANEL

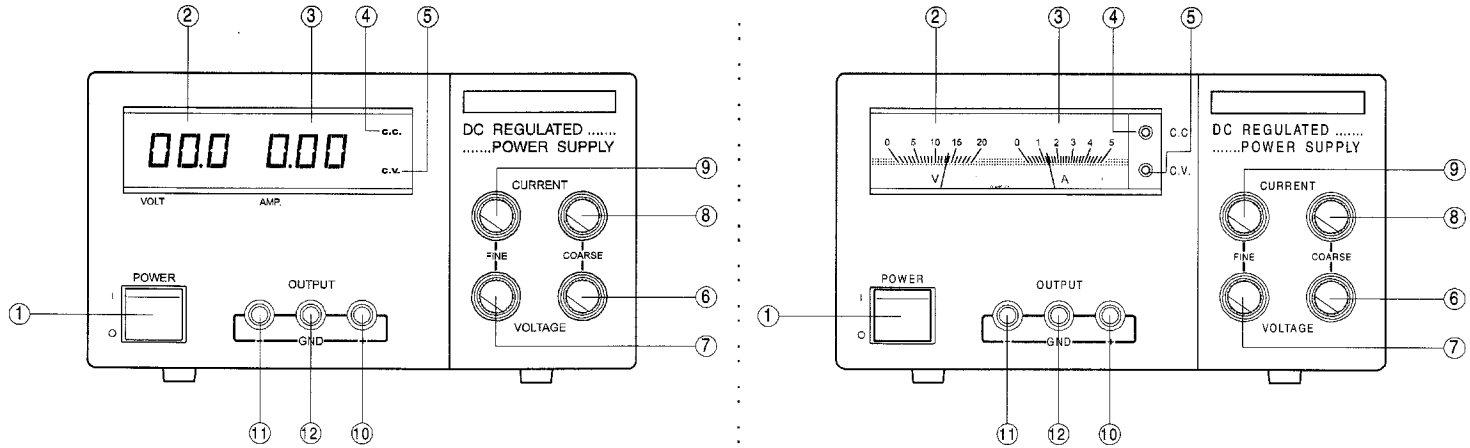

(FIG. 5.1)

1. POWER SWITCH

Turns the power supply ON-OFF the switch will be lighted up when the unit is ON.

2. DC VOLTMETER

Indicates the present output voltage. (Analog meter for 1620, 1622, 1626 and LED meter for 1621, 1623, 1627.)

3. DC AMMETER

Indicates the present output current. (Analog meter for MPA-series and LED meter for MPD-series.)

4. CONSTANT CURRENT MODE (C.C.) INDICATOR

Indicates the power supply is operating in constant current mode.

5. CONSTANT VOLTAGE MODE (C.V.) INDICATOR

Indicates the power supply is operating in constant voltage mode.

6. VOLTAGE COARSE

Coarse adjust knob for the output voltage in voltage

7. VOLTAGE FINE ADJUST

Fine adjust knob for the output voltage in voltage mode.

8. CURRENT COARSE ADJUST

Coarse adjust knob for current limiting point and current value in constant current mode.

9. CURRENT FINE ADJUST

Fine adjust knob for current limiting point and current value in constant current mode.

10. OUTPUT TERMINAL POSITIVE(+)

Terminal for tapping of positive(+) output.

11. OUTPUT TERMINAL NEGATIVE(-)

Terminal for tapping of negative(-) output.

12. GND TERMINAL(\perp)

Chassis ground terminal. normally, this is connected to either the (+) or (-) terminal depend on application.

5 - 2. REAR PANEL

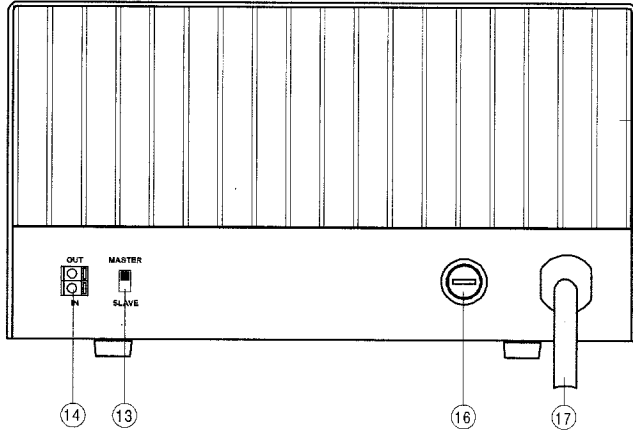

(FIG. 5.2)

13. MASTER/SLAVE SWITCH

Used during "master / slave control" parallel operation in MASTER/SLAVE configuration. For normal operation, switch should be set to MASTER.

14. IN/OUT TERMINALS FOR MASTER/SLAVE OPERATION

Control terminals for use in the "MASTER/SLAVE control" parallel operation mode.

15. HEAT SINK

Heat sink for the power supply. Be careful as this area can become quite hot during operation.

16. MAIN FUSE

17. POWER CABLE

6. OPERATION PROCEDURES

6.1. STAND-ALONE OPERATION

When using the power supply in stand -alone mode, simply operate by manipulation of the panel switches and adjustment knobs as needed.

However, be sure that MASTER/SLAVE switch is set to MASTER position.

6.2 SERIAL CONNECTION

Two or more units of the power supply can be hooked up in series to achieve higher output voltage. The resulted output will be the sum of the outputs of the individual units. In this situation, however, care must be taken that the voltage of neither of the terminals with respect to the chassis GND exceed the ground proof voltage.

- SINGLE VOLTAGE CONNECTION

For connection as shown in FIG. 6.1, the output voltage will be the sum of individual supplies and the output current will be limited to within the value specified for a single unit whichever is lower. For positive ground system, use the short bar to hook-up the ground terminal to output positive point and for

negative ground system , hook-up the ground terminal to the negative output point.

- PLUS / MINUS CONNECTION

For connection as shown in FIG. 6.2 where the intermediate point is hooked up to ground, the configuration can be used as Plus / Minus power supply.

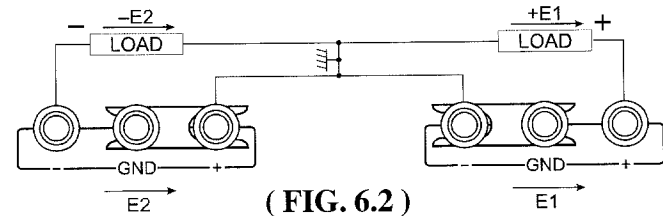
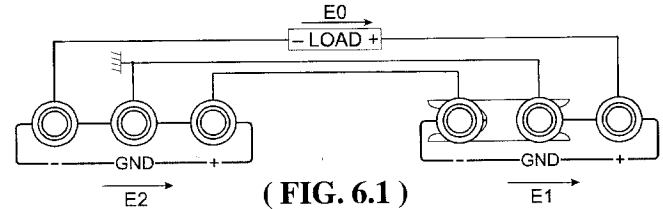

6.3 PARALLEL OPERATION (MASTER/ SLAVE CONTROL

Two or more units of the same model can be hooked up in parallel to give an increase in output current capacity. The total output current capacity will be the sum of the output currents of the individual units. In this mode of operation, one supply will act as the master and all others will act as slaves. The output voltage is set from the master unit.

- Note : When connecting the supplies in parallel, be sure that all the power supplies are turned OFF.

- HOOK-UP PROCEDURES

1. Switch OFF the power of all units.
2. Switch the master/slave switch, FIG. 6.3 , on all the slave units from "MASTER" to "SLAVE" position.
3. Hook-up the IN/OUT terminals for MASTER/SLAVE operation as shown in FIG. 6.3.
4. Connect the output terminals of each of the units to the load as shown in FIG. 6.4 . For proper performance, use all cords of same length.
5. Set the voltage and current adjustment knobs of

all the slave units to the maximum position.

6. Switch "ON" the MASTER unit and SLAVE units. The output voltage and current can then be controlled to the desired value via the adjustment knobs on the MASTER unit.

In case of output goes to "0" amperes in the parallel operation mode, output voltage can no longer be controlled by the master machine.

Be sure to keep a minimum current flowing that is several percent of the rated current for all the time.

- CONNECTION OF TERMINAL ON REAR PANEL

While pressing on the slit portion of the terminal with an small screw driver, insert the connecting cable into the round hole. When insertion is completed, release the screw driver. (FIG. 6.5)

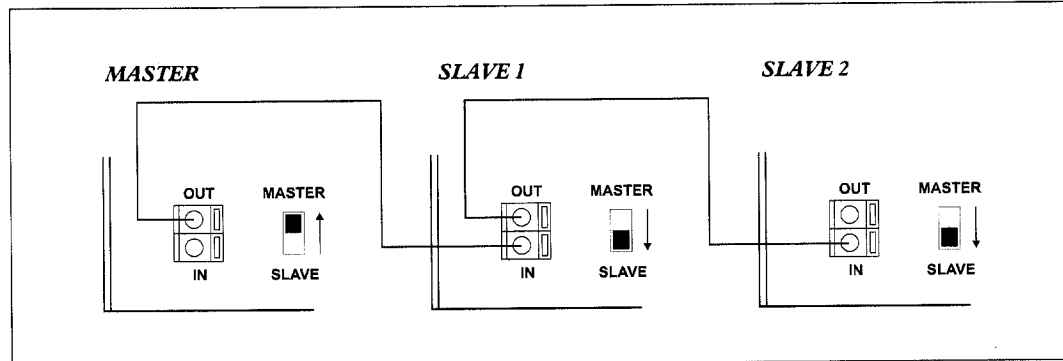

FIG. 6.3

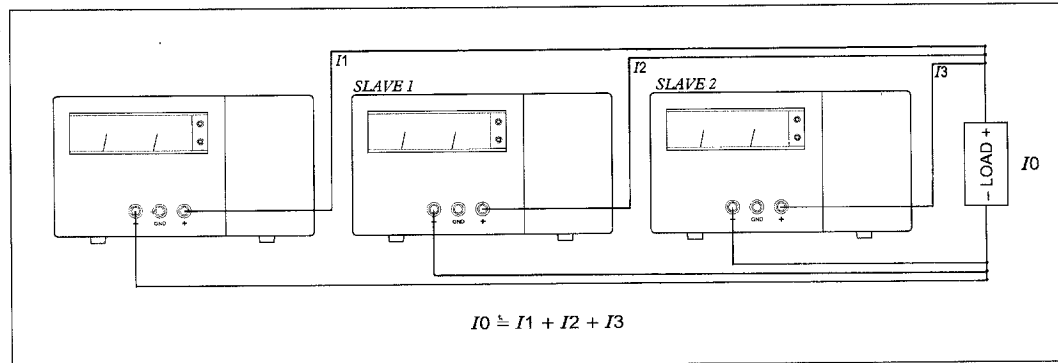

FIG. 6.4

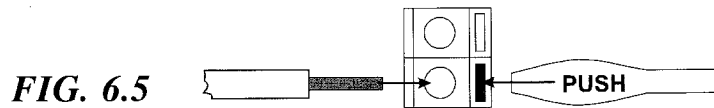

FIG. 6.5

7. MAINTENANCE

WARNING : The following instructions are for use by qualified personnel only. To avoid electrical shock, do not perform any servicing other than contained in the operating instructions unless you are qualified to do so.

7.1 MAIN FUSE REPLACEMENT

If the main fuse blows, the power on the LED indicator will not light and power supply will not operate. The fuse should not normally open unless a problem has developed in the unit. Try to determine and correct the cause of the blown fuse, then replace only with a fuse of correct rating. The fuse is located on the rear panel and fuse rating can be found next to the fuse holder. If the problem persists, return the unit to the agent for further investigation.

7.2 CALIBRATIONS

This unit was accurately calibrated at the factory before shipment. Re-calibration is recommended only if repairs have been made in a circuit affecting calibration accuracy, or if you have a reason to believe the unit is out of calibration.

However, calibrations should be attempted only if a

3¹/₂ digit multimeter with an accuracy of +0.5% DCV or better and a 0 to 50ohm, 250 Watt adjustable resistive load is available.

If re-calibration is required, use procedures described in below. Location of the electrical calibrations on the main PCB are shown in FIG. 7.1.

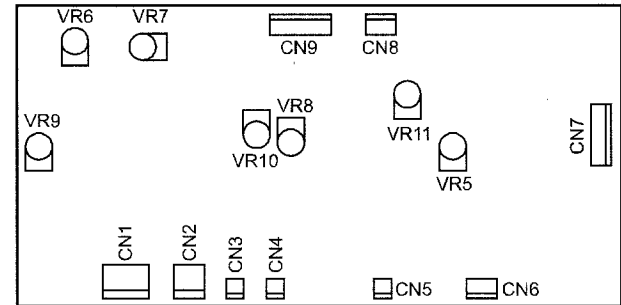

(FIG. 7.1)

7.3 VOLTAGE CALIBRATION

- 1. Connect the multimeter to measure the DC voltage across the power supply (+) and (-) output terminals.**
- 2. Turn on the power supply, and turn the panel VOLTAGE adjustment knob fully clockwise (maximum output).**
- 3. Adjust trimmer VR11 for a reading ($V_{max}+0.5$)+0.1 volts on the multimeter. V_{max} is the maximum nominal output of the specific model under calibration.**

7.4 VOLTMETER ALIGNMENT

- 1. Set the output voltage to about half the maximum allowable output for respective model.**
- 2. Align the voltmeter reading with the multimeter reading.**

For BK Precision Analog series, adjust the trimmer VR-6 on the main PCB.

For BK Precision Digital series, adjust the trimmer VR-1 on the back of meter PCB.

7.5 CURRENT CALIBRATION

- 1. Connect the 0 - 50ohm/250W resistive load in series with the multimeter to measure the DC output current terminals.**

- 2. Adjust trimmer VR-5 fully anti-clockwise. (referring to the component side).**
- 3. Adjust the output voltage to the its maximum allowable output for respective model.**
- 4. Adjust the variable resistive load to obtain ($I_{max}+0.1$)+0.02Ampere on the multimeter. I_{max} is the maximum nominal allowable output current of respective model.**
- 5. Adjust trimmer VR-5 clockwise slowly until the limiting point is just reached and the C.C. LED lights up at the same time.**

7.6 AMMETER ALIGNMENT

- 1. Adjust the output voltage to half of its maximum allowable output voltage for respective model.**
- 2. Adjust the variable resistive load to obtain half of its maximum allowable current for respective model.**
- 3. Align the ammeter reading with the multimeter reading.**

For BK Precision Analog series, adjust the trimmer VR-7 on the main PCB.

For BK Precision Digital series, adjust the trimmer VR-2 on the back of meter PCB.

P/N: 481-375-9-001
Printed in China

©2002 B&K Precision Corp.
7673-3030-1016

22820 Savi Ranch Parkway
Yorba Linda, California 92887
800-462-9832
www.bkprecision.com

BK PRECISION®